



BEFESTIGUNGSSET GZ 294

OGRO LÖSUNG ZUR EINSEITIGEN BEFESTIGUNG DER KONSOLENGRIFFE TG 9391 UND TG 9394

OGRO

- Geeignet für Profile aus Metall und Kunststoff
- Ermöglicht die flächenbündige Montage auf dem Profil mittels selbstschneidendem Gewindeinsatz
- Die Befestigung ist von außen nicht sichtbar und liegt komplett verdeckt im Profil
- Alle Bauteile sind aus hochwertigem Edelstahl „Made in Germany“
- Art.-Nr. 90050065307
- Montageanleitung unter <https://www.ogro.de/downloads>

EDV Nr. 459034

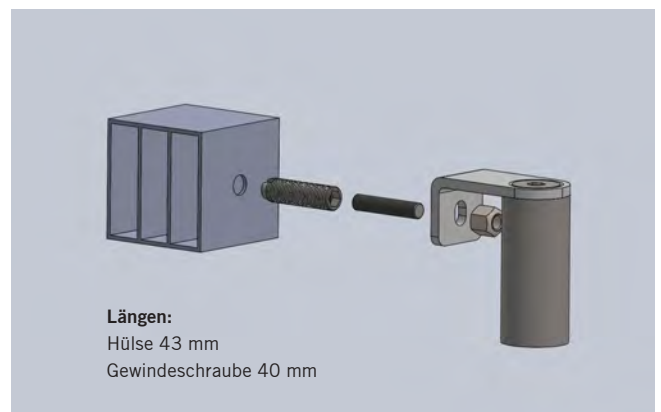
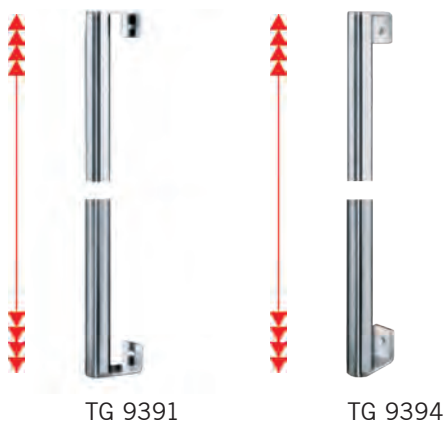

GZ 294

Griffbefestigung für TG 9391 / TG 9394



...die bessere Lösung



RÜTÜ - EDV Nr. 459034

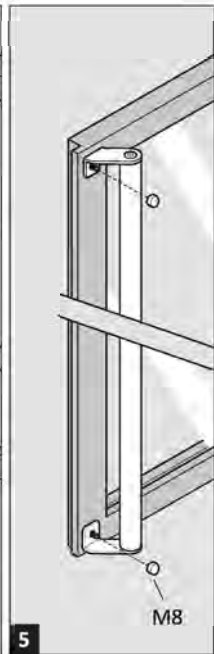
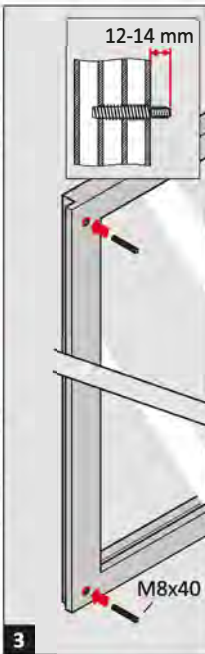
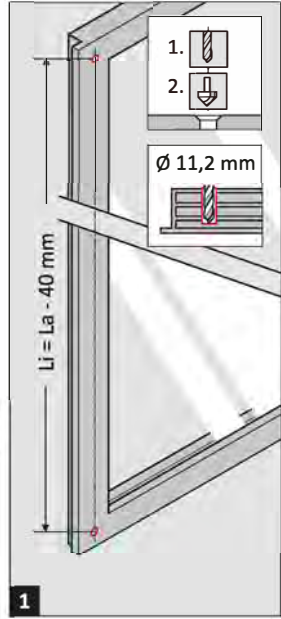
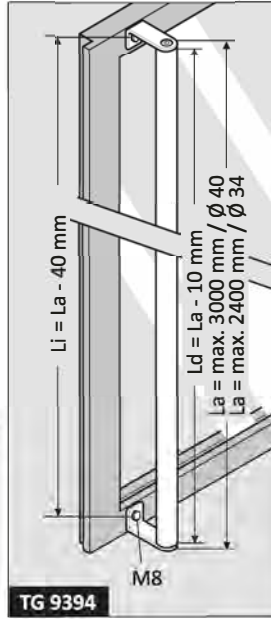
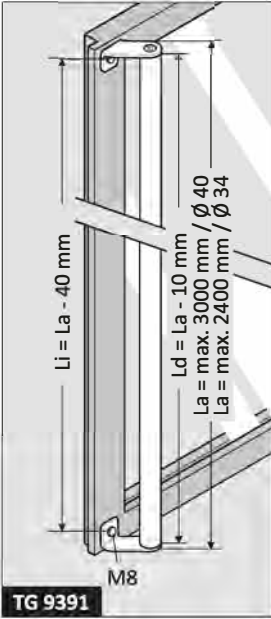

Änderungen vorbehalten
Subject to change without notice