

HomeTec Pro™

Funk-Tastatur CFT3000



- (GB) HomeTec Pro Wireless keypad | (FR) HomeTec Pro Clavier sans fil
(NL) HomeTec Pro Draadloos toetsenbord | (IT) HomeTec Pro Tastiera ad onde radio
(ES) HomeTec Pro Teclado por radio



- (DE) Einsatzbereich | (GB) Possible uses | (FR) Application
(NL) Toepassing | (IT) Possibilità d'impiego | (ES) Aplicaciones
- (DE) Lieferumfang | (GB) Scope of delivery | (FR) Étendue de la livraison
(NL) Leveringsomvang | (IT) Dotazione | (ES) Contenido
- (DE) Montagewerkzeug | (GB) Tools required | (FR) Outillage
(NL) Gereedschap | (IT) Utensili di montaggio | (ES) Herramientas necesarias
- (DE) Montage | (GB) Installation instructions | (FR) Instructions de montage
(NL) Montageaanwijzing | (IT) Istruzioni di montaggio | (ES) Instrucciones de montaje
- (DE) Bedienung | (GB) Operation | (FR) Utilisation
(NL) Bediening | (IT) Uso | (ES) Funcionamiento
- (DE) Rechtliche Hinweise | (GB) Legal information | (FR) Mentions légales
(NL) Wettelijke aanwijzingen | (IT) Note legali | (ES) Advertencias legales

1.

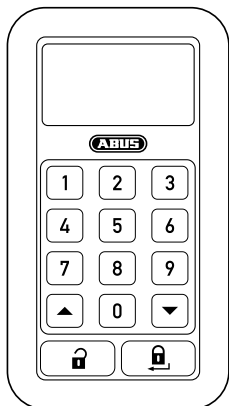

(DE)

Die Tastatur wurde speziell für die Bedienung des HomeTec Pro Funk-Türschlossantriebs entwickelt. Mittels Code-Eingabe wird die Tür ver- und entriegelt. Nach der Entriegelung öffnet sich die Tür automatisch. Die Tastatur ist staub- und spritzwassergeschützt (IP54) und besitzt eine sehr hohe UV-Stabilität.

(GB)

The keypad has been specially developed for the HomeTec Pro wireless door lock actuator. A code is entered to lock and unlock the door. Once unlocked, the door will open automatically. The keypad is dust-proof and splash-proof (IP54 rating) with extremely high UV resistance.

(FR)

Le clavier a été développé spécialement pour le mécanisme de verrouillage radiocommandé HomeTec Pro. La porte se verrouille et déverrouille à l'aide d'un code. Après déverrouillage, la porte s'ouvre automatiquement. Le clavier est protégé contre la poussière et les projections d'eau (IP54). Il est également très résistant aux UV.

(NL)

Het toetsenbord werd speciaal ontwikkeld voor de bediening van de HomeTec Pro draadloze deurslotaandrijving. De deur wordt ver- en ontgrendeld door middel van de invoer van een code. Na de ontgrendeling opent de deur automatisch. Het toetsenbord is beschermd tegen stof en spatwater (IP54) en heeft een zeer hoge uv-stabiliteit.

(IT)

La tastiera è stata progettata specificamente per il controllo dell'attuatore serratura telecomandato HomeTec Pro. La porta può essere bloccata o sbloccata mediante l'inserimento di un codice. Dopo lo sblocco, la porta si apre automaticamente. La tastiera è protetta contro la polvere e gli spruzzi d'acqua (IP54) ed ha una stabilità molto elevata ai raggi UV.

(ES)





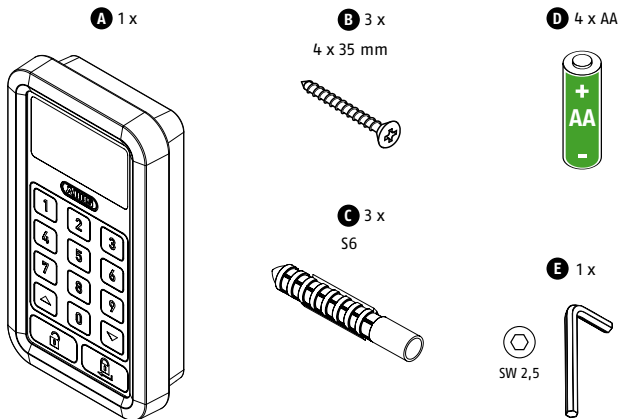

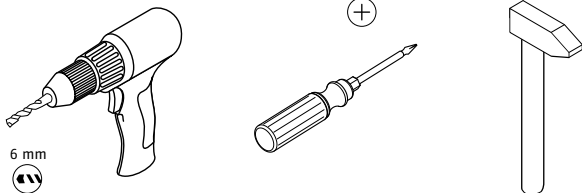

El teclado se desarrolló especialmente para el manejo del accionamiento por radio HomeTec Pro de la cerradura de la puerta. Al introducir el código, la puerta se cierra y se desbloquea. Tras el desbloqueo, la puerta se abre de forma automática. El teclado cuenta con una protección contra el polvo y contra el agua (IP54) y posee una gran estabilidad a los rayos UV.

2.



- A** (DE) Funk-Tastatur | (GB) Wireless keypad | (FR) Clavier sans fil | (NL) Draadloos toetsenbord | (IT) Tastiera ad onde radio | (ES) Teclado por radio
- B** (DE) Schraube | (GB) Screw | (FR) Vis | (NL) Schroef | (IT) Vite | (ES) Tornillo
- C** (DE) Dübel S6 | (GB) Dowel S6 | (FR) Dübel S6 | (NL) Treknagel S6 | (IT) Tassello S6 | (ES) Pasador S6
- D** (DE) Batterie | (GB) Battery | (FR) Batterie | (NL) Batterij | (IT) Batterie | (ES) Batería
- E** (DE) Innensechskantschlüssel | (GB) Hexagon socket wrench | (FR) Clé à douille hexagonale | (NL) Inbussleutel | (IT) Chiave a brugola | (ES) llave macho de hexágono interior

3.

4. INFO 1

			
	Vorsicht!	Hinweise	Achtung! Kleinteile können von Kindern verschluckt werden!
	Caution!	Further fitting details	Attention! Children can swallow small parts!
	Attention!	Instructions de montage	Attention! Les petites pièces peuvent être avalées par les enfants!
	Voorzichtig!	Instructies voor de montage	Let op! Kleine onderdelen kunnen door kinderen worden ingeslikt
	Attenzione!	Note per l'installazione	Attenzione! Piccole parti possono essere ingerite dai bambini!
	Posibles daños materiales.	Instrucciones de montaje	¡Atención! ¡Las piezas pequeñas podrían ser ingeridas por los niños!



Wählen Sie einen geeigneten Montageort für die Tastatur außerhalb Ihrer Wohnung/Ihres Hauses aus, der nahe an der zu bedienenden Tür liegt und von allen Benutzern unterschiedlicher Körpergröße gut erreichbar ist. Testen Sie vor der Montage die Funkverbindung zu Ihrem Antrieb.

»53 d

Aufgrund der sehr unterschiedlichen Gegebenheiten von Außenwänden sollte die

Montage entsprechend angepasst und fachgerecht ausgeführt werden. Je nach Untergrund können Sie die Tastatur zusätzlich zum Schrauben auch z.B. mit Silikon verkleben.

4. INFO 2

(GB)

Select a suitable place to install the keypad. This should be outside your home close to the door it controls and be easily accessible to all users regardless of their height. Test the radio connection to your drive before installation.

»» 5.3 d

Installation should be carried out professionally and adapted to suit the widely differing characteristics of external walls. Depending on the surface in question, the keypad may also be affixed with an adhesive such as silicone in addition to screws.

(FR)

Montez le clavier à un endroit adapté, à l'extérieur de votre maison à proximité de la porte qu'il commande et surtout de façon à être accessible à des utilisateurs de toutes tailles.

Avant le montage, testez la connexion sans fil avec votre commande.

»» 5.3 d

En raison des spécifications différentes des murs extérieurs, le montage doit être réalisé de façon adaptée par un professionnel. Selon le support, le clavier peut être collé avec du silicone, en plus d'être vissé.

(NL)

Kies een geschikte plaats om het toetsenbord te monteren, buitenkant van uw huis, dicht bij de te bedienen deur en goed te bereiken voor alle gebruikers van verschillende lichaamslengtes.

Test voor de montage de radioverbinding met uw deurslotaandrijving.

»» 5.3 d

Gezien de zeer verschillende kenmerken van buitenmuren dient de montage dienooreenkomstig te worden aangepast en vakkundig te worden uitgevoerd. Afhankelijk

van de ondergrond kunt u het toetsenbord naast het vastschroeven ook bijv. vastlijmen met siliconen.

(IT)

Scegliere un luogo adatto per il montaggio della tastiera al di fuori della vostra casa, che deve essere collocata vicino alla porta da controllare e facilmente raggiungibile da tutti gli utenti di diverse altezze. Prima del montaggio, provare la connessione radio dell'attuatore.

»» 5.3 d

Il montaggio deve essere realizzato professionalmente e in modo adeguato alle strutture dei più diversi tipi di parete esterna. A seconda della superficie di montaggio, oltre al fissaggio per mezzo delle viti, si può anche incollare la tastiera con silicone.

(ES)

Elija un lugar apropiado para el montaje del teclado exterior de su casa, que esté cerca de la puerta que haya que manejar y en un lugar alcanzable por todos los usuarios de diferentes alturas.

Antes del montaje compruebe la conexión por radio con el accionamiento.

»» 5.3 d

Debido a las diferentes calidades de las paredes exteriores, el montaje se ha de realizar correctamente y por profesionales. Dependiendo de la base, el teclado se puede pegar también, por ejemplo, con silicona, además de atornillarlo.

4.1 a

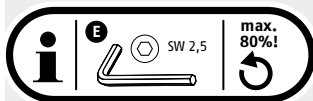
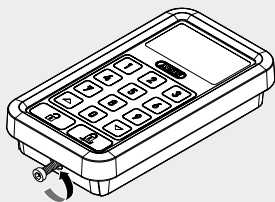

4.1 b

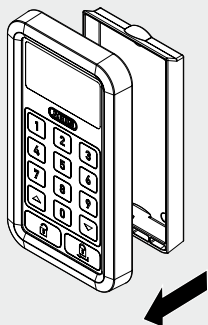

4.1 c

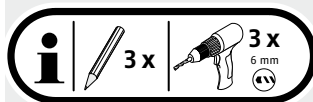
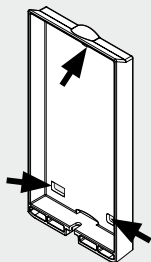

4.1 d

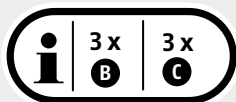
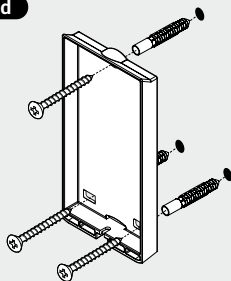

4.1 e

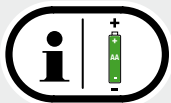
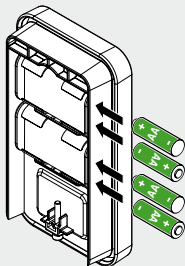

4.1 f

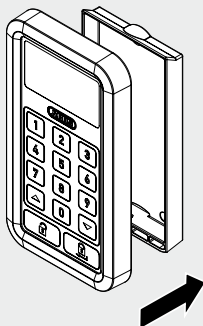

4.1 g

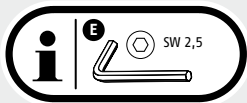
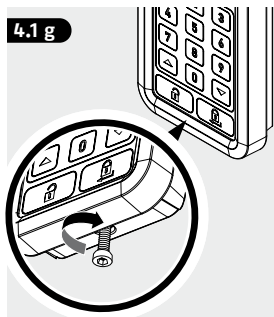

4. INFO 3

1.



2.

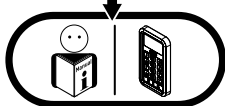

- Ⓓ Beachten Sie zum Einlernen der Tastatur die Anleitung Ihres HomeTec Pro Funk-Türschlossantriebs
- Ⓖ Follow the instructions for your HomeTec Pro wireless actuator
- Ⓕ Respectez les instructions de votre mécanisme radiocommandé HomeTec Pro,
- Ⓓ Neem de handleiding van uw HomeTec Pro afstandsbedrijving in acht,
- Ⓘ Osservare le istruzioni del HomeTec Pro con attuatore telecomandato,
- Ⓔ Tenga en cuenta las instrucciones de su accionamiento por radio HomeTec Pro

5.

F

- Ⓓ LCD Anzeigefeld
- Ⓖ LCD Display
- Ⓕ Voyants LCD
- Ⓓ LCD-weergaveveld,
- Ⓘ Campo di visualizzazione a LCD
- Ⓔ Panel LCD

H

- Ⓓ Navigation „hoch“
- Ⓖ "up" navigation
- Ⓕ flèche «haut»
- Ⓓ navigatie "omhoog"
- Ⓘ navigazione "su"
- Ⓔ navegación «arriba»

J

- Ⓓ Entriegeln/Verlassen
- Ⓖ unlock/exit
- Ⓕ déverrouiller/quitter
- Ⓓ ontgrendelen/verlaten
- Ⓘ sblocco/uscita
- Ⓔ desbloquear/abandonar

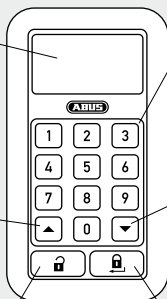

G

- Ⓓ Ziffern 0-9
- Ⓖ digits 0-9
- Ⓕ chiffre 0-9
- Ⓓ cijfers 0-9
- Ⓘ cifre 0-9
- Ⓔ cifras 0-9

I

- Ⓓ Navigation „runter“
- Ⓖ "down" navigation
- Ⓕ flèche «bas»
- Ⓓ navigatie "omlaag"
- Ⓘ navigazione "giù"
- Ⓔ navegación «abajo»

K

- Ⓓ Verriegeln/Bestätigen
- Ⓖ lock/confirm
- Ⓕ verrouiller/confirmer
- Ⓓ vergrendelen/bevestigen
- Ⓘ blocco/confirma
- Ⓔ cerrar/confirmar

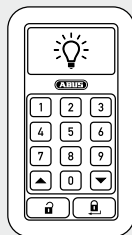
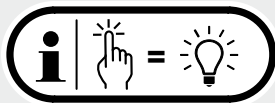





5.1**5.2****TIP
DISPLAY****5.3**

- Ⓓ DE Menü und Programmierung: Seite 9 - 16
- Ⓖ B GB Menu and programming: Page 16 - 21
- Ⓕ FR Menu et programmation: Page 22 - 27
- Ⓒ NL Menu en programmeren: Pagina 28 - 33
- Ⓘ IT Menu e programmazione: Pagina 34 - 39
- Ⓔ ES Menú y programación: Página 40 - 45

Inhaltsverzeichnis:

1. Generelle Einstellungen
2. Programmierung als Administrator
 - a. MENÜ SPRACHE - Sprache festlegen
 - b. MENÜ KALENDER - Zeit und Datum einstellen
 - c. MENÜ ADMINCODE - Administrator-Code ändern
 - d. MENÜ EINLERNEN - Anmeldecode zum Antrieb senden
 - e. MENÜ BENUTZER - Benutzer verwalten
 - f. MENÜ ANTRIEB - Einstellungen des Antriebs ändern
 - g. MENÜ WERKSRESET - auf Auslieferungszustand zurücksetzen
 - h. MENÜ ZEITZONE - Zutrittszeiten einrichten
 - i. MENÜ HISTORIE - Ereignisprotokoll auslesen
 - j. MENÜ SETUP - Einstellungen der Tastatur ändern

Generelle Einstellungen

		 	 - 
abbrechen/ verlassen	bestätigen/ auswählen	Navigation	Ziffern

- Bei Einlegen der Batterien erscheint für ca. 5 Sek. das ABUS Logo; danach das Codefeld
- Bei Wecken der Tastatur durch Klopfen (5.2) erscheint direkt das Codefeld
- Bei jeder Tasteneingabe erfolgt eine akustische Rückmeldung. Hinweis: Signal kann ausgeschaltet werden (5.3 j).
- Jede Eingabe einer Codezahl erzeugt einen ● im Display, d.h. 5 (-10) Ziffern ●●●●●
- Eine mehrfach falsche Codeeingabe führt zu einer zeitlichen Eingabesperre
- Nach ca. 120 Sekunden ohne Eingabe wechselt das System zurück zur Code-Eingabe
- Anzeige Batterie schwach/leer für Antrieb und Tastatur im Display als Warnung
- Sobald „Automatisch Verriegeln“ aktiviert wurde, fragt die Tastatur den Status des Antriebs im festgelegten Zeitraum zyklisch ab (ca. alle 15 Minuten). Wenn in dieser Zeit die Tür als entriegelt gemeldet wurde, wird sie automatisch wieder verriegelt.

Eingabe des Admin-Codes
zwingend erforderlich!

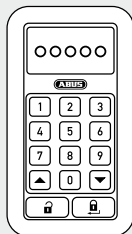

ADMIN CODE:
12345



- Um die Tastatur korrekt einzulernen sind die folgenden Menüpunkte a-e erforderlich
- Optionale Konfigurationsmöglichkeiten bieten die Menüpunkte f-j.

a. MENÜ SPRACHE

Deutsch, English, Italiano, Espanol, Français, Nederlands

abbrechen bestätigen

b. MENÜ KALENDER

Zeit Format [hh:mm], - .



Datum Format [tt:mm:jjjj], - .



Tag

Montag, Dienstag, ..., Sonntag bestätigen

abbrechen bestätigen

c. MENÜ ADMINCODE

Änderung des Admin-Codes zwingend erforderlich! Der Admin-Code dient nur zum Konfigurieren der Tastatur. Zum Bedienen muss zwingend ein Benutzer angelegt werden (MENÜ e).

Bisherigen Code eingeben: - 

Neuen Code eingeben: -  (Hinweis: 5-10 stellig.)



Code nochmals eingeben: - 

Erfolgreiche Änderung wird angezeigt. Bei Fehlermeldung entsprechenden Fehler beheben.

 bestätigen, um ins Hauptmenü zurück zu gelangen.

d. MENÜ EINLERNEN

Hinweis: Der Antrieb muss im Einlernmodus sein. Siehe Anleitung CFA3000.  Tür 1, Tür 2, Tür 3. Hinweis: wenn Sie mehrere Antriebe an versch. Türen nutzen, wählen Sie den gewünschten aus und senden den Anmelde-Code von der Tastatur zum Antrieb.

 Anmelde-Code wird gesendet. Türantrieb Quittung OK?  Erneut 

 abbrechen  bestätigen

e. MENÜ BENUTZER

 Benutzer 1, Benutzer 2, ... Benutzer 32.

Benutzer aktiv, Benutzer inaktiv, Benutzer nicht angelegt.

Hinweis: um einen neuen Benutzer anzulegen, wählen Sie einen mit gekennzeichneten Benutzer und bestätigen mit .

Name: Benutzer  Im Display erscheint die Zuordnung der Zeichen zu den Zahlenfeldern auf der Tastatur.

Alphabet/Zahlen

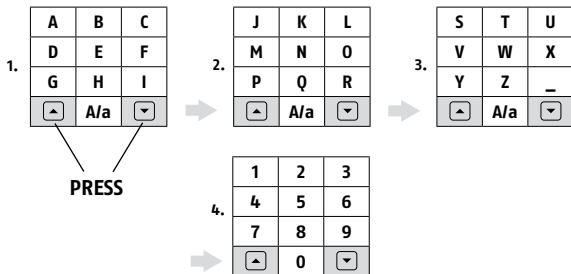

Groß/Klein

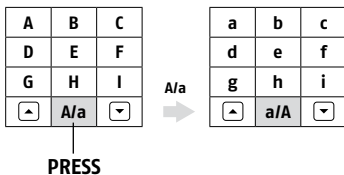

Mehrfachbelegung

1 x Press!	2 x Press!	3 x Press!	4 x Press!	5 x Press!	6 x Press!
A/a	Á/á	À/à	Â/â	Ã/ã	Æ/æ
C/c	Ç/ç				
E/e	É/é	È/è	Ê/ê	Ë/ë	
I/i	Í/í	Ì/ì	Î/î	Ï/ï	
N/n	Ñ/ñ				
O/o	Ó/ó	Ò/ò	Ô/ô	Ö/ö	Ɔ/œ
s	ß				
U/u	Ú/ú	Û/û	Û/û	Ü/ü	
Y/y	ÿ/ÿ				
[leer]	-	.	:	/	\

Wechsel zum nächsten Zeichen mit . Speichern des Namens mit 3 Sek. .
Abbrechen mit .

CODE: ○○○○ Hinweis: 5-10 stellig, -, Code nochmal eingeben!

TÜR: 1 Hinweis: wenn Sie mehrere Antriebe verwenden, hier die Tür auswählen.

1 Zuordnung der ersten Zeitzone.

2 Zuordnung der zweiten Zeitzone

Hinweis: Sie können den Zugang des Benutzers zeitlich einschränken, sonst besteht uneingeschränkter Zutritt. Zur Einrichtung der Zeitzone siehe MENÜ h. Wählen Sie **AKTIV** zum Aktivieren des Benutzers. Nur aktive Benutzer





können die Tastatur nutzen! Sie können aktive Benutzer auch inaktiv setzen (Einstellungen bleiben erhalten, Bedienung ist nicht möglich) oder löschen (Benutzer wird komplett gelöscht).





 abbrechen  bestätigen







f. MENÜ ANTRIEB







 Tür 1, Tür 2, Tür 3. Hinweis: wenn Sie mehrere Antriebe an versch. Türen nutzen, wählen Sie den gewünschten aus.

























Übersicht  Fahrzyklen: zeigt an, wie oft die Falle gezogen, entriegelt und verriegelt wurde. Schloss: zeigt die Position des Schlosses an (verriegelt oder entriegelt). Die Zahl in Klammern zeigt die installierte Software-Version an.

Umbenennen  Bei mehreren genutzten Antrieben können Sie Namen vergeben (z.B. Haustür, Garage, usw.). Zuordnung der Zeichen siehe: **5.3** e. Wechsel zum nächsten Zeichen mit . Abspeichern des Namens mit 3 Sek. . Abbrechen mit .



Ohne Code  Verriegeln ohne Code. Hinweis: Ist „Verriegeln ohne Code“ ausgewählt, reicht das Drücken von  zum Verriegeln.  Inaktiv, aktiv.
 abbrechen  bestätigen

Automatik  Automatisches Verriegeln
 Inaktiv, aktiv.
Wird die Funktion aktiviert, können Sie eine Zeit von – bis einstellen, in der der Antrieb automatisch verriegelt. [hh:mm], -
Hinweis: in der eingestellten Zeit findet regelmäßig eine Abfrage statt (ca. alle 15 min.) ob der Antrieb verriegelt ist. Diese Funktion führt zu höherem Energieverbrauch.
 abbrechen  bestätigen











Touch-
bedienung  Bedienung der Tasten des Antriebs
 Aktiv: alle Tasten des Antriebs können bedient werden.
 Bedientasten: es sind die beiden Pfeiltasten am Antrieb deaktiviert
 Inaktiv: es sind alle Tasten am Antrieb deaktiviert.
 abbrechen  bestätigen

- Falle-Dauer  Haltezeit der Falle bei Öffnung der Tür.
Wählbar mit  von 1 bis 20 Sekunden.
 abbrechen  bestätigen
- Falle-Kraft   Mittel, Niedrig, Hoch. (Empfehlung: für optimale Lebensdauer von Antrieb und Schlüssel die Einstellung „Mittel“/„Niedrig“ wählen.)
 abbrechen  bestätigen
- Signal  Einstellen des Tonsignals beim Antrieb
 Falle: Signal ertönt nur bei Zurückziehen der Falle
 Verriegelt: Signal ertönt nur bei Verriegelung
 Jede Endlage: Signal ertönt bei Öffnung und Verriegelung
 Inaktiv: es ertönt bei keiner Position ein Signal
 Fahrbeginn: Signal ertönt bei Beginn der Öffnungs- oder Verriegelungsfahrt
 abbrechen  bestätigen
- Reduziert  Verriegelung erfolgt um eine Tour reduziert (z.B. eintourig, auch wenn die Tür zweitourig schließt und öffnet). Wir empfehlen auf Dauer zweitourig zu verriegeln.
 Automatik, 1x Schließung.
 abbrechen  bestätigen
- Antrieb-Kraft  Einstellen der Fahrgeschwindigkeit des Antriebs. (Auf Dauer sollte die Einstellung „Automatik“ gewählt werden.)
 Automatik, Maximum.
 abbrechen  bestätigen
-

g. MENÜ WERKSRESET

Mit  wechseln von NEIN auf JA. 3 Sek.  bestätigt. Werksreset wird durchgeführt.
Alle Einstellungen werden gelöscht.  abbrechen

h. MENÜ ZEITZONE

 Zeitzone A, Zeitzone B, ... Zeitzone 0 (insgesamt 15 Zeitzonen).
Öffnen Sie die Programmierung der 1. Zeitzone mit . Richten Sie verschiedene Zugangszeiten ein. Diese können Sie unter MENÜ e. verschiedenen Nutzern zuordnen.
Scrollen Sie mit  durch die Tage.  setzt den Tag aktiv (X) oder inaktiv ().
Zeit von  Format [hh:mm],  - , bis  Format [hh:mm],  - .

abbrechen bestätigen

i. MENÜ HISTORIE

Zeigt die letzten Ereignisse des Antriebs an, z.B. Benutzer 1 entriegelt.

Hinweis: es wird das letzte Ereignis angezeigt, mit kann zum Ereignis davor gewechselt werden. Maximal werden 32 Ereignisse angezeigt, wobei das älteste mit dem neuesten überschrieben wird. Beim Verriegeln ohne Code oder automatischem Verriegeln erfolgt der Eintrag „Admin“.

abbrechen bestätigen

j. MENÜ SETUP

Begrüßung Zuordnung der Zeichen siehe: **>>53** e.

Wechsel zum nächsten Zeichen mit . Abspeichern des Namens mit 3 Sek. . Abbrechen mit .

Signal Konfigurieren des Signaltons ein, aus, leise.

Leuchtzeit Leuchtzeit des Displays mit wählbar von 2-10 Sek. + Nachleuchtzeit.

abbrechen bestätigen

5.3 Menu and programming







Contents:

1. General settings

2. Administrator programming

- a. MENU LANGUAGE - set language
- b. MENU CALENDAR - set time and date
- c. MENU ADMIN CODE - change administration code
- d. MENU TEACH IN - send login code to drive
- e. MENU USER - manage users
- f. MENU DRIVE - change drive settings
- g. MENU FACTORY RESET - reset to state at delivery
- h. MENU TIME ZONE - set access times
- i. MENU HISTORY - read event log
- j. MENU SETUP - change keyboard settings

General settings

		 	 - 
cancel/ exit	confirm/ select	Navigation	Digits

- When inserting the batteries, the ABUS logo appears for approx. 5 seconds; thereafter the code field
- When waking the keyboard by knocking (5.2), the code field opens
- An acoustic feedback is given with each keyboard entry. Note: Signal can be turned off (5.3j).
- For the entry of a code number an ● is created on the display, i.e. 5 (-10) digits ●●●●●
- Multiple incorrect code entries result in a temporary blocked entry status
- After approx. 120 seconds without entry, the system changes back to the code entry status
- Low/empty battery for drive and keyboard shown on the display as warning
- As soon as "Automatic Locking" is enabled, the keyboard queries the status of the drive in a pre-determined period (approx. every 15 minutes). If a door is reported as unlocked in this time, it is automatically locked again.

Entry of the Admin Code is mandatory here!

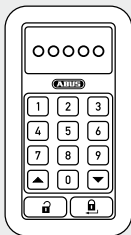



**ADMIN CODE:
12345**





- To teach the keyboard correctly menu a-e is required
- Optional configuration options offer the menu f-j.

a. MENU LANGUAGE



 Deutsch, English, Italiano, Espanol, Français, Nederlands

 cancel  confirm

b. MENU CALENDAR



Time  Format [hh:mm],  0-9.





Date  Format [dd:mm:yyyy],  0-9.





Day 



 Monday, Tuesday, ..., Sunday  confirm

 cancel  confirm

c. MENU ADMIN CODE

Changing the admin code is required! The admin code is used only to configure the keyboard. To operate it is necessary to create a user (MENU e).

Enter previous code:  0 -  9 





Enter new code:  0 -  9  (Note: 5-10 digits.)

Re-enter code:  0 -  9 

Successful change is displayed. In case of an error message, rectify the relevant error.

 confirm, to return to the main menu.

d. MENU TEACH IN

Note: The drive must be in teach-in mode. See CFA3000 instructions.  Door 1, Door 2, Door 3. Note: if you are using multiple drives on different doors, select the required drive and send the login code from the keyboard to the drive.  Sending login code. Door drive confirmation OK?  Again 

 cancel  confirm

e. MENU USER

 User 1, User 2, ... User 32.

User active, User not active, User not applied

Note: to create a new user, select the user marked with and confirm with 

Name: User  The assignment of the characters to the numeric fields on the keypad will appear.

Alphabet/Numbers

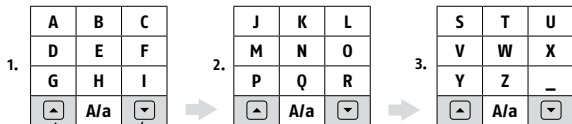

PRESS

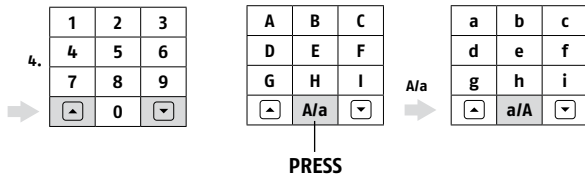

High/Low





Multiple occupancy



1 x Press!	2 x Press!	3 x Press!	4 x Press!	5 x Press!	6 x Press!
A/a	Á/á	À/à	Â/â	Ä/ä	Æ/æ
C/c	Ç/ç				
E/e	É/é	È/è	Ê/ê	Ë/ë	
I/i	Í/í	Ì/ì	Ï/ï	ÿ/ÿ	
N/n	Ñ/ñ				
O/o	Ó/ó	Ò/ò	Ô/ô	Ö/ö	Œ/œ
s	ß				
U/u	Ú/ú	Ù/ù	Û/û	Ü/ü	
Y/y	ÿ/ÿ				
[space]	-	.	:	/	\

Continue to the next character with . Save the name with 3 seconds .
Cancel with .

CODE: ○○○○  Note: 5-10-digits, 0 - 9,  re-enter code! 



DOOR: 1  Note: if you are using multiple drives, select door here.

 1  assignment of first time zone.

 2  assignment of second time zone







































Note: you can restrict the user's access time, otherwise the user has unrestricted access. To set up the time zone see MENU h.

Press ACTIVE to activate the user. Only active users can use the keyboard! You can also set an active user to inactive (settings remain, operation is not possible) or delete the user (user is deleted entirely).

 cancel  confirm

f. MENU DRIVE

 Door 1, Door 2, Door 3. Note: if you are using multiple drives on different doors, select the required drive.

- Overview  Driving cycles: shows how many times the latch was pulled, unlocked or locked. Lock: shows the lock position (locked or unlocked). The number in the brackets shows the installed software version number.
- Rename  You can assign names when using multiple drives (e.g. front door, garage etc.). Assignment of the characters see **>>>5.3** e. Continue to next character with . Save the name with 3 seconds . Cancel with .
- Without code  Lock without code. Note: If the menu option "lock without code" is selected, you can lock the door simply by pressing .  Inactive, active.  cancel  confirm
- Automatic  Automatic locking
 Inactive, active.
 If this function is enabled, you can set a time from - to, in which the drive locks automatically. [hh:mm]  - 
 Note: In the set time it is regularly (approx. every 15 min.) queried whether the drive is locked. This feature leads to higher energy consumption.
 cancel  confirm
- Touch control  Operating the drive keys
 Active: all drive keys can be operated.
 Operating keys: both arrow keys are deactivated on the drive
 Inactive: all arrow keys are deactivated on the drive.
 cancel  confirm
- Latch time  time for which the latch is stopped when opening the door.
 Can be selected with  from 1 to 20 seconds.
 cancel  confirm
- Latch power   Medium, Low, High. (Recommendation: for optimal service life of the drive and key, select the "Medium"/"Low" setting.)
 cancel  confirm
- Signal  Setting the acoustic in the drive
 Latch: signal only sounds when pulling back the latch
 Locked: signal only sounds when locked
 Each end position: signal sounds when opened or locked
 Inactive: no signal sounds for any position
 Start of drive: signal sounds at the start of the opening or locking drive
 cancel  confirm

Reduced Locking is reduced to one-speed (e.g. one-speed even for two-speed locking and opening of the door). We recommend permanent two-speed locking.

Automatic, 1x closing.

cancel confirm

Drive power Setting the drive speed. (The "Automatic" setting should be set permanently.)

Automatic, Maximum.

cancel confirm

g. MENU FACTORY RESET

Change with from NO to YES. 3 seconds confirms. Factory reset is performed. All settings are deleted. cancel

h. MENU TIME ZONE

Time zone A, time zone B, ... time zone 0 (total of 15 time zones).

Open the programming of the 1st time zone with . Set the different access times.

You can assign these to different users under MENU e.

Scroll through the days with . sets the day as active (X) or inactive ().

Time from format [hh:mm], 0 - , to format [hh:mm], 0 - .

cancel confirm

i. MENU HISTORY

Shows the events of the drive, e.g. user 1 unlocked.

Note: the last event is shown, with one can switch to the event before the last event.

Maximum of 32 events are shown, whereby the latest overwrites the oldest. The entry „admin“ is logged in the event log for unlocking without a code or automatically locking.

cancel confirm

j. MENU SETUP

Greeting Assignment of the characters see **5.3** e. Continue to next character with . Save the name with 3 seconds . Cancel with .

Signal Configuring the acoustic feedback on, off, low.

Display light time The display light time can be selected with from 2-10 seconds + afterglow time.







cancel confirm

5.3 Menu et programmation

Table des matières:

1. Paramètres généraux
2. Programmation en tant qu'administrateur
 - a. MENU LANGUE - Choix de la langue
 - b. MENU CALENDRIER - Régler l'heure et la date
 - c. MENU CODE ADMIN - Modifier le code administrateur
 - d. MENU APPRENTISSAGE - Transmettre le code de connexion à la commande
 - e. MENU UTILISATEUR - Gérer l'utilisateur
 - f. MENU COMMANDE - Modifier les paramètres de la commande
 - g. MENU RÉTABLISSEMENT CONFIGURATION D'ORIGINE - Rétablir la configuration d'origine
 - h. MENU FUSEAU HORAIRE - Configurer les horaires d'accès
 - i. MENU HISTORIQUE - Lire le journal d'évènements
 - j. MENU SETUP - Modifier les paramètres du clavier

Paramètres généraux

		 	 - 
annuler/ quitter	confirmer/ sélectionner	Navigation	Chiffres

- Quand on insère les piles, le logo ABUS s'affiche pendant env. 5 s.; le champ du code apparaît ensuite.
- Le champ du code s'affiche directement quand on active le clavier en le tapotant (5.2).
- Un signal acoustique retentit à chaque saisie clavier. Remarque: le signal peut être désactivé (5.3j).
- Un ● apparaît lors chaque saisie d'un chiffre du code, c-à-d. 5 (à 10) chiffres ●●●●●.
- En cas de saisie répétée d'un code erroné, la saisie se verrouille pour une durée spécifique.
- Le système permet de nouveau la saisie du code au bout de env. 120 secondes d'inactivité.
- Affichage à l'écran comme avertissement Pile faible/vide pour la commande et le clavier
- Aussitôt que « Verrouiller Automatiquement » est activé, le clavier interroge le statut de la commande de façon cyclique pendant une durée définie (env. toutes les 15 minutes). Si la porte est signalée comme déverrouillée pendant cette durée, elle est automatiquement verrouillée.

Saisie impérative du code Admin!

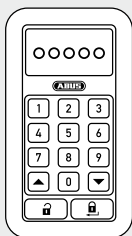





CODE ADMIN:
12345





- Pour enseigner le clavier correctement menu a-e est obligatoire.
- Options de configuration en option offrent menu f-j.

a. MENU LANGUE



  Deutsch, English, Italiano, Espanol, Français, Nederlands

 annuler  confirmer

b. MENU CALENDRIER

Heure  format [hh:mm],  - .



Date  format [jj:mm:aaaa],  - .



Jour









Lundi, Mardi, ..., Dimanche  confirmer



 annuler  confirmer

c. MENU CODE ADMIN

Modification impérative du code Admin! Le code Admin est uniquement pour configurer le clavier. Pour utilisation il doit être créé un utilisateur (MENU e).

Saisir le code actuel:  -  

Saisir le nouveau code:  -   (Remarque: 5 à 10 caractères)







Saisir de nouveau le code actuel:  -  



La confirmation de la modification s'affiche. En cas de message d'erreur, supprimer les défauts correspondants.

 confirmer pour retourner au menu principal.



d. MENU APPRENTISSAGE

Remarque: la commande doit être en mode d'apprentissage. Voir mode d'emploi CFA3000.

  Porte 1, porte 2, porte 3. Remarque : si vous utilisez plusieurs commandes sur différents portes, sélectionnez celle souhaitée et transmettez le code de connexion du clavier à la commande.  Le code de connexion est transmis. Acquiescement de la commande de la porte OK ?  Répéter  

 annuler  confirmer

e. MENU UTILISATEUR

  Utilisateur 1, Utilisateur 2, ... Utilisateur 32.

Utilisateur actif, Utilisateur inactif, Utilisateur pas créé

Remarque: pour créer un nouvel utilisateur, sélectionnez un utilisateur marqué d'un

et confirmez avec 

Nom: utilisateur  L'affectation des caractères aux champs numériques du clavier s'affice à l'écran.

Alphabet/Nombres

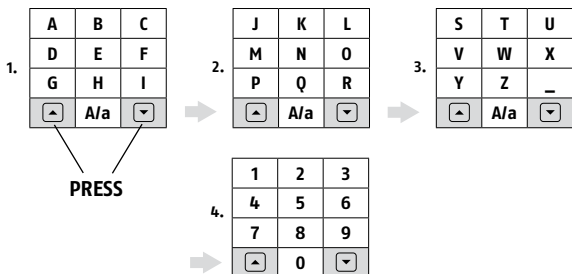

Haut/Petit

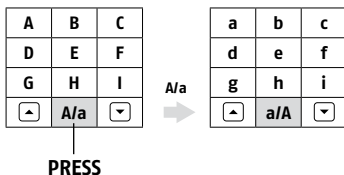

Occupation multiple

1 x Press!	2 x Press!	3 x Press!	4 x Press!	5 x Press!	6 x Press!
A/a	Á/á	À/à	Â/â	Ä/ä	Æ/æ
C/c	Ç/ç				
E/e	É/é	È/è	Ê/ê	Ë/ë	
I/i	Í/í	Ì/ì	Î/î	Ï/ï	
N/n	Ñ/ñ				
O/o	Ó/ó	Ò/ò	Ô/ô	Ö/ö	Œ/œ
s	ß				
U/u	Ú/ú	Û/û	Û/û	Ü/ü	
Y/y	ÿ/ÿ				
[espace]	-	.	:	/	\

Passer au caractère suivant avec . Sauvegarde du nom en 3 s. . Annuler avec .

CODE: ○○○○ Remarque: 5 à 10 caractères, - , Saisir à nouveau le code

PORTE: 1 Remarque: si vous utilisez plusieurs commandes, sélectionner ici la porte.

1 Attribution du premier fuseau horaire.

2 Attribution du deuxième fuseau horaire

Remarque: vous pouvez restreindre l'accès de l'utilisateur dans le temps, sinon il a un accès illimité. Pour la configuration du fuseau horaire, voir MENU h. Appuyez sur ACTIF pour activer l'utilisateur. Seuls les utilisateurs actifs peuvent utiliser le clavier ! Vous pouvez aussi définir les utilisateurs actifs comme inactifs (les paramè-tres restent les mêmes, une utilisation n'est pas possible) ou les supprimer (l'utilisateur sera complètement effacé).

annuler confirmer

f. MENU COMMANDE



Porte 1, porte 2, porte 3. Remarque: si vous utilisez plusieurs commandes sur différents portes, sélectionnez celle souhaitée.

Aperçu Cycles de fonctionnement: indique combien de fois le pêne a été actionné, verrouillé et déverrouillé. Serrure: indique la position de la serrure (verrouillée ou déverrouillée). Le nombre entre parenthèses indique la version du logiciel installé.

- Renommer En cas d'utilisation de plusieurs commandes, vous pouvez leur attribuer des noms (p. ex.: porte d'entrée, garage, etc.). L'affectation des caractères voir **»5.3** e. Passer au caractère suivant avec . Sauvegarde du nom en 3 s. . Annuler avec .
- Sans code Verrouiller sans code. Remarque: si «Verrouiller sans code» est sélectionné, il suffit d'appuyer sur pour verrouiller. Inactif, actif.
 annuler confirmer
- Automatique Verrouillage automatique
 Inactif, actif.
 Quand la fonction est activée, vous pouvez définir une durée de / à, pendant laquelle la commande se verrouille automatiquement. [hh:mm], - Remarque: une interrogation a régulièrement lieu pendant la durée définie (env. toutes les 15 min.) pour savoir si la commande est verrouillée. Cette fonction conduit à une consommation d'énergie plus élevée.
 annuler confirmer
- Commande tactile Utilisation des touches de la commande
 Actif: toutes les touches de la commande peuvent être utilisées.
 Touches de commande: les deux touches de défilement sont désactivées sur la commande
 Inactif: toutes les touches de la commande sont désactivées.
 annuler confirmer
- Durée pêne Durée de maintien du pêne lors de l'ouverture de la porte. Sélectionnable avec de 1 à 20 secondes.
 annuler confirmer
- Force du pêne Moyenne, faible, forte. (Recommandation: pour une durée de vie optimale de la commande et de la clé, sélectionner «Moyenne»/«Faible».)
 annuler confirmer
- Signal Réglage du signal acoustique sur la commande
 Pêne: le signal retentit uniquement quand on dégage le pêne.
 Verrouillé: le signal retentit uniquement en cas de verrouillage.
 Chaque position finale: le signal retentit en cas d'ouverture et de verrouillage.
 Inactif: aucun signal ne retentit en toute position.
 Départ de la course: le signal retentit au départ de la course d'ouverture ou de verrouillage.
 annuler confirmer
- Réduit Le verrouillage est réduite une rotation (p.ex. s'effectue qu'en un tour, même si la porte s'ouvre et se ferme en deux tours). À long terme, nous

recommandons le verrouillage à deux tours.



 Automatique, 1 tour de fermeture.

 annuler  confirmer



Puissance de

la commande  Réglage de la vitesse de course de la commande. (À long terme, sélectionner le réglage «Automatique».)



 Automatique, Maximum.



 annuler  confirmer



g. MENU RÉTABLISSEMENT CONFIGURATION D'ORIGINE

 Permet de passer de NON à OUI. Actionné pendant  3 s. Le rétablissement de la configuration d'origine a lieu. Tous les paramètres sont supprimés.  annuler

h. MENU FUSEAU HORAIRE

 Fuseau horaire A, fuseau horaire B, ... fuseau horaire 0 (15 fuseaux horaires au total). Ouvrez la programmation du 1er fuseau horaire avec . Configurez les différents horaires d'accès. Vous pouvez les assigner à différents utilisateurs au MENU e.

Faites défiler les jours avec .  définit le jour comme actif (X) ou inactif ().



Horaire de  format [hh:mm], 0 - 9, à  format [hh:mm], 0 - 9.

 annuler  confirmer





i. MENU HISTORIQUE



Affiche les plus récents évènements de la commande, p. ex.: utilisateur 1 déverrouillé.

Remarque: affiche le plus récent évènement;  permet de passer à l'évènement précédent. 32 évènements au maximum sont affichés, le plus ancien étant écrasé par le plus récent. En cas de verrouillage sans code ou verrouillage automatique, s'effectue une entrée „admin" dans la mémoire des événements.



 annuler  confirmer

j. MENU SETUP

Salutation  L'affectation des caractères voir  5.3 e. Passer au caractère suivant avec . Sauvegarde du nom en 3 s. . Annuler avec .

Signal  Configurer le signal  on, off, faible.

Durée

d'éclairage  Durée d'éclairage de l'écran sélectionnable avec  de 2 à 10 s. + durée d'éclairage diurne.







 annuler  confirmer

5.3 Menu en programmeren

Inhoudsopgave:

1. Algemene instellingen
2. Programmeren als administrator
 - a. MENU TAAL - taal kiezen
 - b. MENU KALENDER - tijd en datum instellen
 - c. MENU ADMINCODE - administratorcode wijzigen
 - d. MENU INLEREN - aanmeldingscode naar de deurslotaandrijving verzenden
 - e. MENU GEBRUIKERS - gebruikers beheren
 - f. MENU AANDRIJVING - instellingen van de deurslotaandrijving wijzigen
 - g. MENU FABRIEKRESET - fabrieksinstellingen herstellen
 - h. MENU TIJDSZONE - toegangstijden instellen
 - i. MENU HISTORIE - gebeurtenissenlogboek uitlezen
 - j. MENU SETUP - instellingen van het toetsenbord wijzigen

Algemene instellingen

		 	 - 
annuleren / verlaten	bevestigen/ selecteren	Navigeren	Cijfers

- Na het plaatsen van de batterijen wordt na ongeveer 5 s het ABUS-logo weergegeven en daarna het codeveld
- Wanneer het toetsenbord door erop te kloppen (5.2) uit de slaapstand wordt gehaald, wordt direct het codeveld weergegeven
- Elke keer dat een toets wordt ingedrukt genereert het toetsenbord een akoestische terugmelding. Opmerking: Het signaal kan worden uitgeschakeld (5.3j)
- Elk cijfer van de ingevoerde code wordt op de display weergegeven als een ●; dus bij 10 cijfers ●●●●●●●●
- Wanneer meerdere keren na elkaar een verkeerde code wordt ingevoerd, blokkeert het systeem een bepaalde tijd de toegang
- Als het systeem gedurende ongeveer 120 s geen invoer ontvangt, wordt automatisch het codeveld opnieuw op de display weergegeven
- Aanduiding batterij bijna leeg/leeg voor de deurslotaandrijving en het toetsenbord op de display als waarschuwing
- Zodra 'Automatisch vergrendelen' werd geactiveerd, controleert het toetsenbord op gezette tijden de status van de deurslotaandrijving in de ingestelde periode (ongeveer elke 15 minuten). Als het toetsenbord in deze periode de deurstatus ontgrendeld detecteert, wordt de deur automatisch opnieuw vergrendeld.

Invoeren van de administratorcode verplicht!

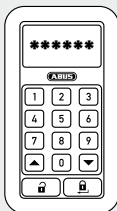



ADMIN CODE:
12345





- Om het toetsenbord correct te leren, de menu items a-e zijn verplicht.
- Optioneel configuratieopties bieden de menu items f-j.

a. MENU TAAL 

 Deutsch, English, Italiano, Espanol, Français, Nederlands

 annuleren  bevestigen

b. MENU KALENDER 

Tijd  notatie [uu:mm],  - .





Datum  notatie [dd:mm:jjjj],  - .



Dag





 Maandag, dinsdag, ..., zondag  bevestigen



 annuleren  bevestigen

c. MENU ADMINCODE 

Wijzigen van de administratorcode verplicht! De admin code wordt alleen gebruikt om het toetsenbord te configureren. Om het te gebruiken, moet een gebruiker ingesteld worden (MENU e).

Voer de huidige code in:  -  









Voer de nieuwe code in:  -   (Opmerking: 5 - 10 cijfers.)

Voer de code nogmaals in:  -  



Wanneer de code met succes is gewijzigd, wordt dat op de display gemeld. Bij een foutmelding de betreffende fout verhelpen.

 bevestigen om terug te keren naar het hoofdmenu.

d. MENU INLEREN

Opmerking: de leermodus van de deurslotaandrijving moet geactiveerd zijn. Zie handleiding CFA3000.   Deur 1, Deur 2, Deur 3. Opmerking: als u meerdere aandrijvingen op verschillende deuren gebruikt, selecteert u de gewenste aandrijving en verzendt u de aanmeldingscode vanaf het toetsenbord naar de deurslotaandrijving.  Aanmeldingscode wordt verzonden... Deurslotaandrijving vrijgeven OK?  Nogmaals  
 annuleren  bevestigen

e. MENU GEBRUIKER

  Gebruiker 1, Gebruiker 2, ... Gebruiker 32.

Gebruiker actief, Gebruiker inactief, Gebruiker niet ingesteld.

Opmerking: om een nieuwe gebruiker in te stellen selecteert u een met een gemarkeerde gebruiker en bevestigt met 

Naam: Gebruiker  In het display worden de koppelingen tussen tekens en de cijfervelden op het toetsenbord weergegeven.

Alfabet/Aantallen

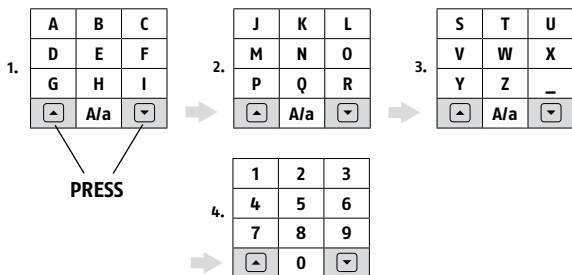

Hoog/Laag

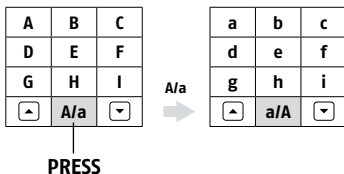

Meervoudig bewoning

1 x Press!	2 x Press!	3 x Press!	4 x Press!	5 x Press!	6 x Press!
A/a	Á/á	À/à	Â/â	Ä/ä	Æ/æ
C/c	Ç/ç				
E/e	É/é	È/è	Ê/ê	Ë/ë	
I/i	Í/í	Ì/ì	Î/î	Ï/ï	
N/n	Ñ/ñ				
O/o	Ó/ó	Ò/ò	Ô/ô	Ö/ö	Œ/œ
s	ß				
U/u	Ú/ú	Û/û	Û/û	Ü/ü	
Y/y	ÿ/ÿ				
[spatie]	-	.	:	/	\

Het volgende teken activeert u met . Sla de naam op door gedurende 3 s  ingedrukt te houden.
Annuleren met .

CODE: ○○○○  Opmerking: 5 - 10 cijfers, 0 - 9,  code nogmaals invoeren 

DEUR: 1  Opmerking: als u meerdere deurslotaandrijvingen gebruikt dient u hier de deur te selecteren.

 1

 2

 Instellen van de eerste tijdzone.

 Instellen van de tweede tijdzone

Opmerking: u kunt de toegang van de gebruiker beperken in de tijd. Als u dat niet doet heeft de gebruiker onbeperkt toegang. Voor het instellen van de tijdzone, zie MENU h. Druk op ACTIEF om de gebruiker te activeren. Alleen geactiveerde gebruikers kunnen het toetsenbord gebruiken! U kunt geactiveerde gebruikers ook inactief maken (instellingen blijven behouden, maar deuren openen is niet mogelijk) of verwijderen (gebruiker wordt volledig verwijderd).

 annuleren  bevestigen



f. MENU AANDRIJVING

 Deur 1, Deur 2, Deur 3. Opmerking: als u meerdere deurslotaandrijvingen gebruikt dient u de gewenste aandrijving te selecteren.

- Overzicht bedieningscycli: geeft aan hoe vaak de schoot getrokken, ontgrendeld en vergrendeld is. Slot: geeft de positie van het slot aan (vergrendeld of ontgrendeld). De getal tussen haakjes is de geïnstalleerde softwareversie.
- Hernoemen Als er meer deurslotaandrijvingen worden gebruikt, kunt u die een naam geven (bijvoorbeeld huisdeur, garage enzovoort). Koppelingen tussen tekens en de cijfervelden zie **5.3** e. Met springt u naar het volgende teken. Sla de naam op door gedurende 3 s. ingedrukt te houden. Annuleren met .
- Zonder code Vergrendelen zonder code. Opmerking: als 'Vergrendelen zonder code' is geselecteerd hoeft u alleen maar in te drukken om te vergrendelen.
 Inactief, actief.
- Automatisch annuleren bevestigen
 Automatisch vergrendelen
 Inactief, actief.
 Als de functie is geactiveerd, kunt u een periode van - tot instellen, waarin de deurslotaandrijving automatisch vergrendelt. [uu:mm], -
 Opmerking: in de ingestelde periode controleert het toetsenbord op gezette tijden (ongeveer elke 15 min.) of de deurslotaandrijving vergrendeld is. Deze functie leidt tot een hoger energieverbruik.
 annuleren bevestigen
- Touch-bediening Bediening van de knoppen van de deurslotaandrijving
 Actief: alle knoppen van de deurslotaandrijving kunnen worden bediend.
 Bedieningstoetsen: de beide pijltoetsen op de deurslotaandrijving zijn gedeactiveerd
 Inactief: alle toetsen op de deurslotaandrijving zijn gedeactiveerd.
 annuleren bevestigen
- Schoot-duur Wachtijd voor de schoot bij openen van de deur.
 Instelbaar met - tussen 1 en 20 seconden.
 annuleren bevestigen
- Schoot-kracht - Middel, Laag, Hoog. (Aanbeveling: kies voor een optimale levensduur van de deurslotaandrijving en de sleutel de instelling „Middel“ of „Laag“.) annuleren bevestigen
- Signaal Instellen van het geluidssignaal bij de deurslotaandrijving
 Schoot: alleen geluidssignaal bij terugtrekken van de schoot
 Vergrendeld: alleen signaal bij vergrendelen
 Elke eindpositie: signaal zowel bij openen als vergrendelen
 Inactief: nooit een signaal bij openen of vergrendelen
 Activering: signaal bij begin van open- of vergrendelbeweging
 annuleren bevestigen

Gereduceerd  vergrendeling is gereduceerd tot een rotatie (bijvoorbeeld met een rotatie, ook wanneer de deur dubbelroterend sluit en opent). Wij raden aan permanent dubbelroterend te vergrendelen.



 Automatisch, 1 x sluiten.

 annuleren  bevestigen



Aandrijving-
kracht

 Instellen van de snelheid van de beweging van de deurslotaandrijving. (Op de lange termijn is het verstandig om de instelling ‚Automatisch‘ te kiezen.)

 Automatisch, maximum.

 annuleren  bevestigen



g. MENU FABRIEKSRESET



Met  wisselen tussen NEE en JA. Door  3 s. ingedrukt te houden bevestigt u uw keuze. De fabriekinstellingen worden hersteld. Alle instellingen worden gewist.  annuleren

h. MENU TIJDZONE

 Tijdzone A, Tijdzone B, ... Tijdzone 0 (in totaal 15 tijdzones).

Open de programmeermodus voor de eerste tijdzone met . Stel verschillende toegangstijden in. In MENU e. wordt beschreven hoe u deze aan verschillende gebruikers toewijst.

Scroll met  door de dagen. Met  maakt u de weergegeven dag actief (X) of inactief ().



Voer de tijd in met  notatie [uu:mm], 0 - 9 , tot  notatie [uu:mm], 0 - 9.

 annuleren  bevestigen

i. MENU HISTORIE



Toont de laatste gebeurtenissen van de deurslotaandrijving, bijvoorbeeld Gebruiker 1 ontgrendelt.



Opmerking: alleen de laatste gebeurtenis wordt weergegeven; met  kunt u de eerstvolgende eerdere gebeurtenis weergeven. Er worden maximaal 32 gebeurtenissen opgeslagen (en weergegeven). Wanneer er meer gebeurtenissen zijn wordt steeds de oudste overschreven. Bij vergrendelen zonder code of automatisch wordt de informatie „admin“ opgeslagen in het gebeurtenissengeheugen.



 annuleren  bevestigen

j. MENU SETUP

Begroeting  Koppelingen tussen tekens en de cijfervelden zie **5.3** e.

Met  springt u naar het volgende teken. Sla de naam op door gedurende 3 s.  ingedrukt te houden. Annuleren met .

Signaal  Configureren van het signaal met ; On, Off, zachter zetten

Verlichtingstijd  Instellen van de verlichtingstijd van de display met ; instelbaar van 2 - 10 s. + naverlichtingstijd.







 annuleren  bevestigen

5.3 Menu e programmazione

Indice:

1. Impostazioni generali
2. Programmazione come amministratore
 - a. MENU LINGUA - consente di scegliere la lingua
 - b. MENU CALENDARIO - consente di impostare ora e data
 - c. MENU ADMINCODE - consente di modificare il codice amministratore
 - d. MENU CODIFICA - consente d'impostare il codice di segnalazione da inviare all'attuatore
 - e. MENU UTENTE - consente di gestire gli utenti
 - f. MENU ATTUATORE - consente di modificare le impostazioni dell'attuatore
 - g. MENU RESET FABBRICA - consente di ripristinare le impostazioni di fabbrica
 - h. MENU FASCIA ORARIA - consente di impostare gli orari di accesso
 - i. MENU STORICO - consente di leggere il protocollo degli eventi
 - j. MENU SETUP - consente di modificare le impostazioni della tastiera

Impostazioni generali

		 	 - 
annulla/ esci	conferma/ seleziona	Navigazione	Cifre

- Quando si inseriscono le batteria, per ca. 5 sec. apparirà il logo ABUS, quindi il campo d'immissione del codice
- Se si riattiva la tastiera picchiando (5.2), apparirà subito il campo d'immissione del codice
- Ad ogni digitazione sarà emesso un segnale acustico di conferma. Note: Segnale può essere disattivato (5.3j).
- Ogni numero di codice immesso genera un ● sul display, ossia 5 (-10) cifre ●●●●●
- Se si immette più volte il codice errato, il campo sarà bloccato per qualche tempo
- Dopo un tempo di attesa di ca. 120 secondi senza inserimento dati, il sistema ritorna all'immissione del codice
- Indicatore su display di batteria in esaurimento/scarica sia dell'attuatore sia della tastiera
- Appena si attiva "Bloccaggio automatico", la tastiera interroga ciclicamente lo stato dell'attuatore nel periodo stabilito (circa ogni 15 minuti). Se in questo tempo la porta sarà segnalata come sbloccata, questa sarà di nuovo bloccata.

È tassativo immettere il codice amministratore!

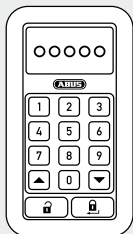



**ADMIN CODE:
12345**



- Per insegnare la tastiera correttamente, menu a-e è necessario.
- Le opzioni di configurazione opzionali offrono menu f-j.

a. MENU LINGUA 

 Deutsch, English, Italiano, Espanol, Français, Nederlands

 per annullare  per confermare

b. MENU CALENDARIO 

Formato  ora [oo:mm], 0 - 9.





Formato  data [gg:mm:aaaa], 0 - 9.



Giorno 

 Lunedì, Martedì, ..., Domenica  per confermare

 per annullare  per confermare

c. MENU ADMINCODE 

È tassativo modificare il codice amministratore! Il codice di amministrazione viene utilizzato solo per configurare la tastiera. Per operare deve necessariamente essere creato un utente (MENU e).

Immettere il codice precedente: 0 - 9 







Immettere il nuovo codice: 0 - 9  (nota: 5-10 cifre.)



Ripetere l'immissione del codice: 0 - 9 

Sarà visualizzato il buon esito della modifica. In caso di segnalazione di errore, rimuovere l'errore corrispondente.



Confermare con  per tornare al menu principale.

d. MENU CODIFICA

Nota: l'attuatore deve trovarsi in modalità autoapprendimento. Si vedano le istruzioni CFA3000.   Porta 1, Porta 2, Porta 3. Nota: se si usano più attuatori su porte diverse, selezionare quello desiderato e inviare il codice di registrazione dalla tastiera all'attuatore.  Invio del codice di registrazione. Conferma di ricezione attuatore porta OK?  Ripetere con  

 per annullare  per confermare

e. MENU UTENTE

  Utente 1, Utente 2, ... Utente 32.

Utente attivo, Utente non attivo, utente non creato.

Nota: per creare un nuovo utente, selezionare un utente contrassegnato con e quindi 

Nome: Utente  Il display visualizza l'abbinamento dei caratteri ai campi numerici sulla tastiera.

Alphabet/Numeri

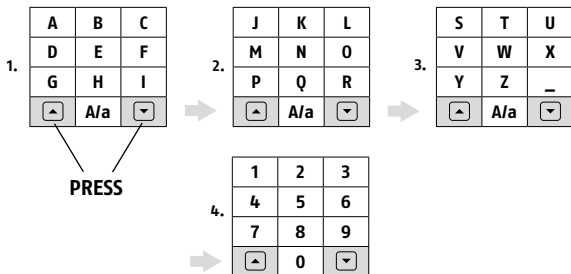

Alto/Piccolo

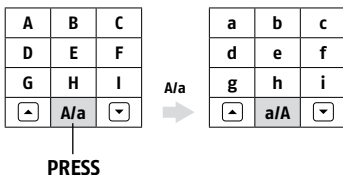

Occupazione multipla

1 x Press!	2 x Press!	3 x Press!	4 x Press!	5 x Press!	6 x Press!
A/a	Á/á	À/à	Â/â	Ä/ä	Æ/æ
C/c	Ç/ç				
E/e	É/é	È/è	Ê/ê	Ë/ë	
I/i	Í/í	Ì/ì	Î/î	Ï/ï	
N/n	Ñ/ñ				
O/o	Ó/ó	Ò/ò	Ô/ô	Ö/ö	Œ/œ
s	ß				
U/u	Ú/ú	Ù/ù	Û/û	Ü/ü	
Y/y	ÿ/ÿ				
[spazio]	-	.	:	/	\

Per passare al carattere successivo, premere . Per memorizzare il nome, premere per 3 sec. Per annullare, .

CODICE: ○○○○ Nota: 5-10 cifre, - , immettere ancora il codice

PORTA: 1

1

2

Nota: se si usano più attuatori, selezionare qui la porta.

Associazione della prima fascia oraria.

Associazione della seconda fascia oraria





Nota: è possibile limitare il tempo di accesso dell'utente, altrimenti l'accesso sarà illimitato. Per impostare la fascia oraria, si veda MENU h. Premere ATTIVO per attivare l'utente. Solo utenti attivi possono usare la tastiera! È possibile anche disattivare utenti attivi (le impostazioni restano, ma non è possibile il comando) o eliminarli (l'utente sarà eliminato completamente).





per annullare per confermare

f. MENU ATTUATORE







Porta 1, Porta 2, Porta 3. Nota: se si usano più attuatori su porte diverse, selezionare quello desiderato.

Riepilogo Cicli di funzionamento: indica quante volte lo scrocco è stato tirato, sbloccato e bloccato. Serratura: indica la posizione della serratura (bloccata o sbloccata). Il numero tra parentesi indica la versione software installata.







Rinomina  Se si usano più attuatori, è possibile assegnare loro dei nomi (ad es., porta di casa, garage, ecc.). L'abbinamento dei caratteri si veda **»»5.3** e. Per passare al carattere successivo, premere . Per memorizzare il nome in 3 sec., . Per annullare, .

Senza codice  Consente di bloccare senza codice. Nota: se è stato selezionato "Blocco senza codice", per bloccare basta premere .  Non attivo, attivo.  per annullare  per confermare





Sistema automatico





 Consente il bloccaggio automatico
 Non attivo, attivo.
 Attivando la funzione, è possibile inserire un orario da - a - , in cui l'attuatore è bloccato in automatico. [oo:mm],  -  
 Nota: nel tempo impostato, avrà luogo regolarmente un'interrogazione (ca. ogni 15 min) per verificare se l'attuatore è bloccato. Questa funzione comporta un maggior consumo energetico.
 per annullare  per confermare

Comando touch









 Consente di comandare i tasti dell'attuatore
 Attivo: si possono comandare tutti i tasti dell'attuatore.
 Tasti di comando: i due tasti freccia in corrispondenza dell'attuatore sono disattivati
 Non attivo: tutti i tasti in corrispondenza dell'attuatore sono disattivati.
 per annullare  per confermare





Durata scrocco





 Tempo di tenuta dello scrocco all'apertura della porta.
 Selezionabile con  a 1 a 20 secondi.
 per annullare  per confermare

Forza scrocco   Media, Bassa, Alta (raccomandazione: per la durata in vita ottimale dell'attuatore e della chiave, selezionare l'impostazione "Media"/"Bassa").
 per annullare  per confermare



Segnale

 Consente d'impostare il segnale sonoro di funzionamento
 Scrocco: il segnale risuona solo quando viene arretrato lo scrocco
 Bloccato: il segnale risuona solo al bloccaggio
 Ogni posizione finale: il segnale risuona all'apertura e al bloccaggio
 Non attivo: nessun posizione farà risuonare un segnale
 Inizio corsa: il segnale risuona all'inizio della corsa di apertura o bloccaggio
 per annullare  per confermare











- Ridotto  Il bloccaggio avviene con una sola mandata, anche quando la porta si apre e chiude con due mandate (nel lungo termine, consigliamo di bloccare con due mandate). Il bloccaggio avviene con una sola mandata, anche quando a porta si apre e chiude con due mandate. Nel lungo termine, consigliamo di bloccare con due mandate.
-  Sistema automatico, n. 1 chiusura.
 per annullare  per confermare



- Forza attuatore  Consente d'impostare la velocità di corsa dell'attuatore (a lungo termine, si consiglia di scegliere l'impostazione "Sistema automatico").
-  Sistema automatico, massimo.
 per annullare  per confermare

g. MENU RESET FABBRICA

Con  si passa da NO a SÌ. Premere per 3 sec.  per confermare. Sarà eseguito il reset alle impostazioni di fabbrica, cancellando tutte le impostazioni successive. Per annullare, 



h. MENU FASCIA ORARIA

 Fascia oraria A, fascia oraria B, ... fascia oraria 0 (in totale 15 fasce orarie).
Aprire la programmazione della 1a fascia oraria con . Impostare diversi orari di accesso. Questi si possono associare a diversi utilizzatori, come spiegato al MENU e. Scorrere i giorni con . Con , impostare il giorno su attivo (X) o non attivo (). Ora d'inizio  in formato [oo:mm],  -  , ora di fine  in formato [oo:mm],  - .







 per annullare  per confermare





i. MENU STORICO

Consente di visualizzare gli ultimi eventi dell'attuatore, ad es., utente 1 sbloccato.
Nota: sarà visualizzato l'ultimo evento; con  è possibile passare all'evento precedente. Saranno visualizzati al massimo 32 eventi, il più vecchio sarà sovrascritto dal più recente. Se si esegue il bloccaggio senza codice o automatico, viene registrato „Admin“ all'interno della memoria degli eventi.

 per annullare  per confermare

j. MENU SETUP

- Saluto  L'abbinamento dei caratteri si veda  e. Per passare al carattere successivo, premere . Per memorizzare il nome, premere  per 3 sec. Per annullare, .
- Segnale  Configurare il segnale con  On, Off, Silenzioso.







Tempo d'illuminazione  Il tempo d'illuminazione del display si seleziona con  da 2 a 10 sec. + un'illuminazione residua.
 per annullare  per confermare

5.3 Menú y programación

Índice:

1. Configuración general
2. Programación como administrador
 - a. MENÚ IDIOMA - Establecer idioma
 - b. MENÚ CALENDARIO - Configurar fecha y hora
 - c. MENÚ CÓDIGO ADMIN - Modificar el código de administrador
 - d. MENÚ PROGRAMACIÓN - Enviar al accionamiento el código de entrada al sistema
 - e. MENÚ USUARIO - Gestionar usuarios
 - f. MENÚ ACCIONAMIENTO - Modificar la configuración del accionamiento
 - g. MENÚ RESTABLECER LOS VALORES DE FÁBRICA - restablecer el estado de entrega
 - h. MENÚ ZONA HORARIA - Configurar los tiempos de acceso
 - i. MENÚ HISTORIAL - Leer el protocolo de eventos
 - j. MENÚ SETUP - Cambiar la configuración del teclado

Configuración general

		 	 - 
cancelar/ abandonar	confirmar/ seleccionar	navegación	cifras

- Al colocar las pilas se abre durante aprox. 5 s. el logotipo de ABUS; después del campo de código
- Al despertar el teclado, dando golpecitos (5.2) se abre directamente el campo de código
- Cada pulsación de una tecla emite una señal acústica. Aviso: Señal puede ser apagado (5.3j)
- Cada entrada de una cifra del código muestra un ● en la pantalla, e.d. 5 (-10) cifras ●●●●●
- Al introducir varias veces un código incorrecto se producirá un bloqueo temporal
- Aprox 120 segundos sin ninguna introducción el sistema retorna a la indicación de código
- Indicador pila débil/vacía para accionamiento y teclado en la pantalla como advertencia
- Tan pronto se haya activado «bloqueo automático», el teclado consulta el estado del accionamiento en intervalos programados (aprox. cada 15 minutos). Si en ese periodo se avisa de puerta desbloqueada se bloquea de nuevo automáticamente.

¡La entrada del código de administrador es obligatoria!

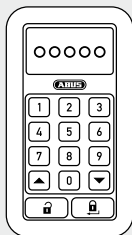





CÓDIGO ADMIN:
12345





- Para enseñar el teclado correctamente se requiere menú a-e
- Opciones de configuración opcionales ofrecen menú f-j.

a. MENÚ IDIOMA



  Deutsch, English, Italiano, Espanol, Français, Nederlands

 cancelar  confirmar

b. MENÚ CALENDARIO

Hora  formato [hh:mm],  - .







Fecha  formato [dd:mm:aaaa],  - .



Día





 lunes, martes, ..., domingo  confirmar



 cancelar  confirmar

c. MENÚ CÓDIGO ADMIN

¡La modificación del código de administrador es obligatoria! El código de administrador sólo se utiliza para configurar el teclado. Para operar es necesario para crear un usuario (MENÚ e.)

Introducir el código de administrador anterior:  -  

Introducir el nuevo código:  -   (aviso: 5-10 cifras)



Introducir el código de nuevo:  -  

Se muestra el cambio exitoso. En caso de mensaje de error solventar el error correspondiente.



 confirmar, para acceder de nuevo al menú principal.

d. MENÚ PROGRAMACIÓN

Aviso: El accionamiento tiene que estar en el modo de programación. Véase el manual CFA3000.  puerta 1, puerta 2, puerta 3. Aviso: si utiliza varios accionamientos en diferentes puertas, seleccione el deseado y envíe el código de registro del teclado al accionamiento.

 Enviando el código de registro... ¿Confirmación accionamiento de la puerta OK? 

De nuevo 

 cancelar  confirmar

e. MENÚ USUARIO

 Usuario 1, Usuario: 2, ... Usuario: 32.

Usuario activo, usuario inactivo, usuario no se ha creado

Aviso: para crear un nuevo usuario, seleccione un usuario marcado con y confirme con 



Nombre: usuario  Aparece en la pantalla la asignación del carácter a los campos numéricos del teclado.

El alfabeto/Números

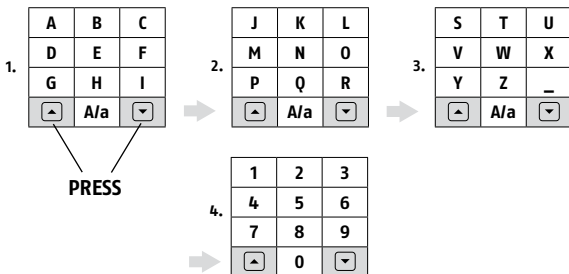

Alta/Baja

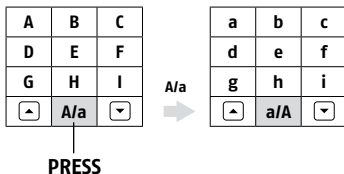

Ocupación múltiple

1 x Press!	2 x Press!	3 x Press!	4 x Press!	5 x Press!	6 x Press!
A/a	Á/á	À/à	Â/â	Ă/ă	Æ/æ
C/c	Ç/ç				
E/e	É/é	È/è	Ê/ê	Ě/ě	
I/i	Í/í	Ì/ì	Î/î	Ī/ī	
N/n	Ñ/ñ				
O/o	Ó/ó	Ò/ò	Ô/ô	Ö/ö	Œ/œ
s	ß				
U/u	Ú/ú	Û/û	Û/û	Ü/ü	
Y/y	ÿ/ÿ				
[espacio]	-	.	:	/	\

Se accede al próximo carácter con . Guardar el nombre con 3 s. . Cancelar con .

CÓDIGO: ○○○○ Aviso: 5-10 caracteres, - , indicar de nuevo el código

PUERTA: 1

1

2

Aviso: si utiliza varios accionamientos, seleccione aquí la puerta.

asignación de la primera zona temporal.

asignación de la segunda zona horaria

Aviso: puede limitar el acceso del usuario temporalmente, sino tiene acceso ilimitado. Para configurar la zona horaria véase MENÚ h. Pulse ACTIVO para activar el usuario. ¡Solo los usuarios activos pueden usar el teclado! Puede pasar los usuarios activos a inactivos (los ajustes siguen igual, no es posible manejar) o borrarlos (el usuario se borra íntegramente).

cancelar confirmar

f. MENÚ ACCIONAMIENTO

puerta 1, puerta 2, puerta 3. Aviso: si utiliza varios accionamientos en diferentes puertas, seleccione el deseado.

Resumen

Ciclos de movimiento: muestra con qué frecuencia se ha echado, desenclavado y enclavado. Cerradura: muestra la posición de la cerradura (enclavada o desenclavada). El número entre paréntesis muestra la versión de software instalada.

- Renombrar** Si utiliza varios accionamientos puede darles nombre (p.ej. puerta principal, garaje, etc.). La asignación del carácter véase **»»» 5.3** e. Se accede al próximo carácter con . Guardar el nombre con 3 s. . Cancelar con .
- Sin código** Enclavar sin código. Aviso: si se ha elegido «Cerrar sin código», es suficiente con pulsar la tecla para cerrar. Inactivo, activo. cancelar confirmar
- Modo automático** Enclavamiento automático
 Inactivo, activo.
 Si se activa la función, puede configurar un tiempo de – a , en el que el accionamiento enclava automáticamente. [hh:mm], -
 Aviso: en el tiempo programado se consulta con regularidad (aprox. cada 15 min.) si el accionamiento está enclavado. Esta función conduce a un mayor consumo de energía
 cancelar confirmar
- Control táctil** Manejo de las teclas del accionamiento
 Activo: se pueden manejar todas las teclas del accionamiento.
 Teclas de manejo: están desactivadas las dos flechas en el accionamiento
 Inactivo: están desactivadas todas las teclas en el accionamiento.
 cancelar confirmar
- Duración pestillo** Tiempo de retención del pestillo al abrir la puerta. Seleccionable con de 1 a 20 segundos.
 cancelar confirmar
- Fuerza del pestillo** media, baja, alta. (Recomendación: para una vida útil óptima de accionamiento y llave, seleccionar la configuración «media»/«baja».)
 cancelar confirmar
- Señal** Configuración de la señal acústica en el accionamiento
 Pestillo: la señal suena solo al retirar el pestillo
 Enclavado: la señal suena solo al enclavar
 Cualquier posición final: la señal suena al abrir y al enclavar
 Inactivo: no suena ninguna señal al posición
 Al comenzar el movimiento: la señal suena al iniciar el movimiento de apertura o enclavamiento
 cancelar confirmar
- Reducido** Solo se enclava con una vuelta, incluso cuando la puerta abre y cierra con dos vueltas de llave. Le recomendamos enclavar a largo plazo con dos vueltas. El bloqueo es una gira reducida (p.ej., una sola velocidad incluso para dos velocidades de bloqueo y apertura de la

- puerta). Le recomendamos enclavar a largo plazo con dos vueltas.
- Modo automático, 1x cierre.
 - cancelar confirmar

- Fuerza del accionamiento: Ajuste de la velocidad de movimiento del accionamiento. (A largo plazo debería seleccionarse el ajuste «automático».)
- Modo automático, máximo.
 - cancelar confirmar

g. MENÚ RESTABLECER LOS VALORES DE FÁBRICA

Con cambiar de NO a SÍ. 3 s. confirmado. Se restablecen los valores de fábrica. Todas las configuraciones se eliminarán. cancelar

h. MENÚ ZONA HORARIA

Zona horaria A, Zona horaria B, ... Zona horaria 0 (en total 15 zonas horarias).

Abra la programación de la 1ª zona horaria con . Configure varias horas de acceso. En MENÚ e. puede asignarlas a diferentes usuarios.

Muévase con por los días. fija el día como activo (X) o inactivo ().

Tiempo de formato [hh:mm], 0 - 9 , hasta formato [hh:mm], 0 - 9.

cancelar confirmar

i. MENÚ HISTORIAL

Muestra los últimos eventos del accionamiento, p. ej. usuario 1 desenclavado.

Aviso: se muestra el último evento, con se puede cambiar al evento anterior. Como máximo se muestran 32 eventos, el más viejo se sobrescribe con el más nuevo. Al enclavar sin código o bloqueo automático es „Admin“ en la memoria de eventos.

cancelar confirmar

j. MENÚ SETUP

Bienvenida La asignación del carácter véase **»5.3** e. Se accede al próximo carácter con . Guardar el nombre con 3 s. . Cancelar con .



Señal Configurar la señal on, off, silencioso.

Período de iluminación Período de iluminación de pantalla seleccionable de 2-10 s. + iluminación posterior.



cancelar confirmar

5.4



DE Bedienung als Benutzer >>5.2

1. Wecken der Tastatur durch Klopfen
2. Code als Benutzer 1, 2, ..., 32 eingeben
3.  öffnen  schließen



GB User Operation >>5.2

1. Wake keyboard by knocking
2. Enter user code 1, 2, ..., 32
3.  open  close



FR Utilisation en tant qu'utilisateur >>5.2

1. Activer le clavier en tapotant
2. Saisir le code comme utilisateur 1, 2, ..., 32.
3.  ouvrir  fermer



NL Bediening als gebruiker >>5.2

1. Toetsenbord uit de slaapstand halen door erop te kloppen
2. Code als gebruiker 1, 2, ..., 32 invoeren
3.  openen  sluiten

IT Operazioni dell'utente >>5.2

1. Riattivazione della tastiera picchiettando
2. Immettere il codice utente 1, 2, ..., 32
3.  per aprire  per chiudere

ES Manejo como Usuario >>5.2

1. Despertar el teclado, dando golpecitos
2. Introducir el código como usuario 1, 2, ..., 32
3.  abrir  cerrar

5.5

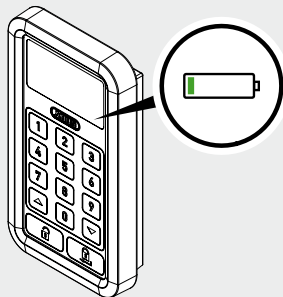

5.5 a

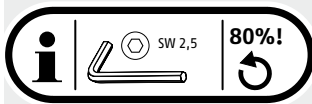
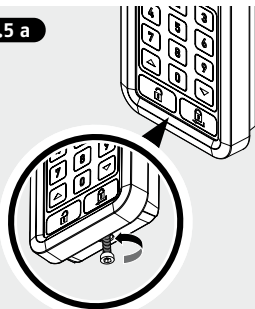

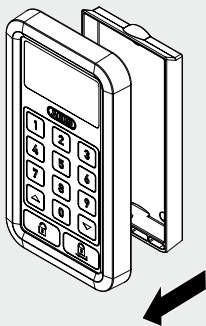
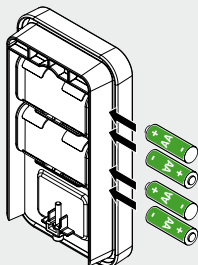
5.5 b

5.5 c

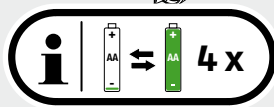
- Ⓓ🇪 Ersetzen Sie stets alle Batterien!
- Ⓖ🇧 Replace all the batteries!
- Ⓕ🇫🇷 Remplacez toutes les piles!
- Ⓒ🇱 Alle batterijen vervangen!
- Ⓘ🇹 Sostituire tutte le batterie!
- Ⓔ🇸 Cambie todas las pilas!

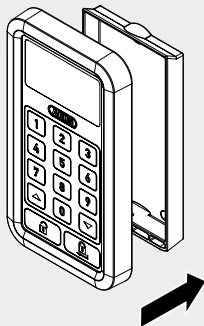

5.5 d



5.5 e

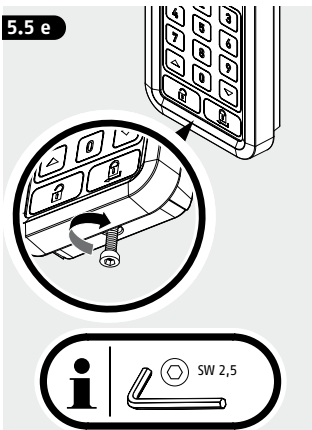

5.5 f

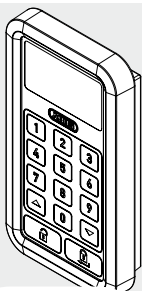

- ⒹE Kein Reinigungsmittel und kein Microfasertuch verwenden!
- ⒼB Do not use cleaning agents and microfibre cloths!
- ⒻR Ne pas utiliser des produits détergents et de chiffon microfibre!
- ⒸL Gebruik geen reinigingsmiddel en microvezeldoeken!
- ⒾT Non utilizzare di prodotti per la pulitura e panni in microfibra!
- ⒺS ¡No utilizar productos de limpieza y paños de microfibra!

DE

Batteriehinweise

Batterien dürfen nicht in die Hände von Kindern gelangen. Kinder können Batterien in den Mund nehmen und verschlucken. Dies kann zu ernsthaften Gesundheitsschäden führen. Suchen Sie in einem solchen Fall sofort einen Arzt auf!

Verätzungsgefahr bei Kontakt mit ausgelaufenen oder beschädigten Batterien! Benutzen Sie in diesem Fall geeignete Schutzhandschuhe und reinigen Sie das Batteriefach mit einem trockenen Tuch.

Batterien dürfen nicht erhitzt oder ins offene Feuer geworfen werden (Explosionsgefahr!).

Gewährleistung

ABUS Produkte sind mit größter Sorgfalt konzipiert, hergestellt und nach geltenden Vorschriften geprüft. Die Gewährleistung erstreckt sich ausschließlich auf Mängel, die auf Material- oder Herstellungsfehler zurückzuführen sind. Falls nachweislich ein Material- oder Herstellungsfehler vorliegt, wird die Funk-Tastatur nach Ermessen von ABUS repariert oder ersetzt. Die Gewährleistung endet in diesen Fällen mit dem Ablauf der ursprünglichen Gewährleistungslaufzeit. Weitergehende Ansprüche sind ausdrücklich ausgeschlossen.

ABUS haftet nicht für Mängel und Schäden, die durch äußere Einwirkungen (z.B. Transport, Gewalteinwirkung), unsachgemäße Bedienung, normalen Verschleiß und Nichtbeachtung dieser Anleitung entstanden sind. Bei Geltendmachung eines Gewährleistungsanspruchs ist dem zu beanstandenden Produkt der originale Kaufbeleg mit Kaufdatum und eine kurze schriftliche Fehlerbeschreibung beizufügen.

Konformitätserklärung

Hiermit erklärt ABUS August Bremicker Söhne KG, Altenhofer Weg 25, 58300 Wetter, dass sich das Gerät HomeTec Pro

bei bestimmungsgemäßer Verwendung in Übereinstimmung mit den grundlegenden Anforderungen und den übrigen einschlägigen Bestimmungen der Richtlinie 2014/53/EU befindet. Die Konformitätserklärung kann unter folgender Adresse bezogen werden: ABUS August Bremicker Söhne KG, Altenhofer Weg 25, 58300 Wetter, Deutschland.

Entsorgung

Entsorgen Sie das Gerät gemäß der Elektro- und Elektronik-Altgeräte EG Richtlinie 2002/96/EC – WEEE (Waste Electrical and Electronic Equipment). Bei Rückfragen wenden Sie sich an die für die Entsorgung zuständige kommunale Behörde. Informationen zu Rücknahmestellen für Ihre Altgeräte erhalten Sie z.B. bei der örtlichen Gemeinde- bzw. Stadtverwaltung, den örtlichen Müllentsorgungsunternehmen oder bei Ihrem Händler.

Technische Änderungen vorbehalten. Für Druckfehler und Irrtümer keine Haftung.



WEEE-Reg.-Nr. DE79663011

GB

Battery instructions

Batteries must be kept out of reach of children. Children can put batteries in their mouths and choke. This can cause serious injury. Seek immediate medical attention in this event!

Contact with expired or damaged batteries may cause chemical burns! In these cases, use suitable protective gloves and clean the battery compartment with a dry cloth. Batteries must not be heated or thrown into an open fire (risk of explosion!).

Warranty

ABUS products are designed, manufactured and tested in accordance with applicable regulations with great care. The warranty

exclusively covers faults that are caused by material or manufacturing defects. If a material or manufacturing defect can be proven, the HomeTec Pro Wireless keypad will be repaired or replaced at the discretion of the warrantor. In such cases, the warranty ends with the termination of the original warranty period. Any further claims are expressly excluded.

ABUS assumes no liability for defects or damage that has been caused by external influences (e.g. transport, external forces), improper use, normal wear and tear or non-compliance with this operating and installation instructions document. If a warranty claim is asserted, the product must be returned with the original receipt with date of purchase and a brief written description of the fault.

Declaration of Conformity

ABUS August Bremicker Söhne KG, Altenhofer Weg 25, 58300 Wetter hereby declares that the HomeTec Pro is in compliance with the essential requirements and other relevant provisions of Directive 2014/53/EU. The declaration of conformity can be obtained from the following address: ABUS August Bremicker Söhne KG, Altenhofer Weg 25, 58300 Wetter, GERMANY.

Disposal

Dispose of the device in accordance with EU Directive 2002/96/EC – WEEE (Waste Electrical and Electronic Equipment). If you have any questions, please contact the municipal authority responsible for disposal. You can get information on collection points for waste equipment from your local authority, from local waste disposal companies or your dealer.

Subject to technical alterations. No liability for mistakes and printing errors.



WEEE-Reg.-Nr. DE79663011

FR

Remarques concernant les piles

Les piles doivent être conservées hors de portée des enfants. Les enfants pourraient les mettre dans la bouche et les avaler. Cela présente de graves risques pour la santé. Dans ce cas, consultez immédiatement un médecin!

Risque d'irritation en cas de contact avec des piles qui fuient ou endommagées ! Dans ce cas, utilisez des gants de protection adaptés et nettoyez le compartiment à piles avec un chiffon sec.

Les piles ne doivent pas être exposées à la chaleur ou jetées dans un feu (risque d'explosion).

Garantie

Les produits ABUS sont conçus, fabriqués et testés avec beaucoup de soin et selon la réglementation applicable. La garantie couvre uniquement les vices résultant de défauts matériels ou de fabrication présents au moment de la vente. En présence d'un défaut matériel ou de fabrication prouvé, le HomeTec Pro Clavier sans fil est réparé ou remplacé au gré du donneur de garantie. La garantie se termine, dans de tels cas, à expiration de la durée d'origine de la garantie. Toute revendication au-delà de cette date est explicitement exclue.

ABUS décline toute responsabilité pour des vices et dommages résultant du milieu ambiant (p. ex. avaries de transport, emploi de la force), d'une utilisation incorrecte, de l'usure normale ou de la non-observation des présentes instructions. En cas d'une demande dans le cadre de la garantie, le objet de la réclamation est accompagné par l'original du justificatif d'achat sur lequel est mentionnée la date d'achat ainsi qu'une brève description du défaut.

Déclaration de conformité

La société ABUS August Bremicker Söhne KG déclare par la présente que le HomeTec Pro lorsqu'il est utilisé selon les directives est

conforme aux exigences fondamentales et aux dispositions en vigueur de la directive 2014/53/EU. La déclaration de conformité est disponible à l'adresse suivante: ABUS August Bremicker Söhne KG, Altenhofer Weg 25, 58300 Wetter, Allemagne.

Elimination

Éliminez l'appareil conformément à la directive UE relative aux déchets d'équipements électriques et électroniques 2002/96/CE - DEEE (Déchets d'Équipements Électriques et Électroniques). En cas de doute, veuillez vous adresser aux organismes régissant l'élimination des déchets. Vous recevrez les informations sur les points de reprise de vos appareils usagés par ex. auprès de la mairie, des entreprises locales de collecte et d'élimination des déchets ou de votre revendeur.

Nous nous réservons le droit de toutes modifications techniques. Nous n'assumons aucune responsabilité pour des erreurs ou défauts d'impression éventuels.



WEEE-Reg.-Nr. DE79663011



Batterij-instructies

Kleine kinderen mogen nooit met batterijen spelen. Kinderen kunnen batterijen in hun mond stoppen en doorslikken. Dit kan ernstige gevolgen hebben voor de gezondheid. Neem in dergelijke gevallen direct contact op met een arts!
Gevaar op verwondingen door uittredend zuur bij contact met uitgelopen of beschadigde batterijen! Gebruik in dat geval geschikte beschermende handschoenen en reinig het batterijvak met een droge doek. Batterijen mogen niet verhit of in open vuur gegooid worden (explosiegevaar!).

Garantie

ABUS producten zijn met de grootste zorgvuldigheid ontworpen, geproduceerd en op basis van de geldende voorschriften getest. De garantie heeft uitsluitend betrekking op gebreken die op materiaal- of fabrieksfouten duiden op het moment van verkoop. Bij bewijs van een materiaal- of fabrieksfout wordt de HomeTec Pro Draadloos toetsenbord na beoordeling van de garantiegever gerepareerd of vervangen. De garantie eindigt in dit geval met het aflopen van de oorspronkelijke garantieperiode. Verdergaande aanspraken zijn uitdrukkelijk uitgesloten. ABUS is niet aansprakelijk voor gebreken en schade die zijn veroorzaakt door inwerkingen van buitenaf (bijvoorbeeld door transport, inwerking van geweld), onjuist gebruik, normale slijtage of het niet in acht nemen van deze handleiding. Bij het indienen van een garantieclaim moet bij de digitale deurspion het originele aankoopbewijs met datum van de aankoop en een korte schriftelijke beschrijving van de fout worden gevoegd.

Conformiteitsverklaring

Hiermee verklaart ABUS August Bremicker Söhne KG, dat het apparaat HomeTec Pro voldoet aan de essentiële eisen en overige geldende bepalingen van de richtlijn 2014/53/EU. De conformiteitsverklaring kunt u aanvragen via het onderstaande adres: ABUS August Bremicker Söhne KG, Altenhofer Weg 25, 58300 Wetter, Duitsland.

Afvoer

Voor het apparaat af zoals beschreven in de EG-richtlijn 2002/96/EG betreffende afgedankte elektrische en elektronische apparatuur – WEEE (Waste Electrical and Electronic Equipment). Bij vragen wendt u zich tot de voor de afvoer bevoegde gemeentelijke dienst. Informatie over verzamelpunten voor afgedankte apparatuur krijgt u bij de gemeente, regionale afvalbedrijven of bij uw verkoper.

Technische wijzigingen voorbehouden.
Geen aansprakelijkheid voor vergissingen en drukfouten.



WEEE-Reg.-Nr. DE79663011



Note sulle batterie

Le batterie devono essere tenute fuori dalla portata dei bambini. I bambini potrebbero metterle in bocca e inghiottirle. Questo può causare gravi danni alla salute. In tal caso, consultare immediatamente un medico! Qualora le batterie presentino delle perdite o siano danneggiate, sussiste pericolo di lesioni! In questo caso, indossare guanti protettivi adatti e pulire il vano batterie con un panno asciutto.

Le batterie non devono essere riscaldate o gettate nel fuoco (rischio di esplosione!).

Garanzia

I prodotti ABUS sono progettati con la massima cura, costruito e collaudato in conformità alle direttive vigenti in materia. La garanzia copre esclusivamente gli inconvenienti a difetti di materiale o di fabbricazione. Nel caso in cui sia comprovato un difetto di materiale o di fabbricazione la HomeTec Pro Tastiera ad onde radio verrà riparato o sostituito a discrezione del garante. La garanzia di qualità termina in questi casi alla scadenza del periodo originario di garanzia. Si escludono espressamente ulteriori pretese.

ABUS non è responsabile per difetti o danni causati da fattori esterni (ad esempio trasporto, uso forzato), da un utilizzo non appropriato, dal normale logoramento o dalle mancate osservanze delle presenti istruzioni. Qualora si faccia valere una pretesa di garanzia, allegare al spioncino elettronico d'acquisto originale contenente la data d'acquisto, e una breve descrizione scritta del difetto.

Dichiarazione di conformità

ABUS August Bremicker Söhne KG, Altenhofer Weg 25, 58300 Wetter dichiara con la presente che l'apparecchio con il codice articolo HomeTec Pro è quando utilizzato in modo appropriato conforme ai requisiti essenziali e alle disposizioni vigenti della direttiva 2014/53/EU. La dichiarazione di conformità può essere ottenuta al seguente indirizzo: ABUS August Bremicker Söhne KG, Altenhofer Weg 25, 58300 Wetter, Germania.

Smaltimento

Smaltire il dispositivo in conformità con gli obblighi dispositivi elettrici ed elettronici usati Direttiva CE 2002/96 / CE - RAEE (Rifiuti da apparecchiature elettriche ed elettroniche). Per informazioni, si prega di contattare le autorità locali competenti per lo smaltimento. Di informazioni sui punti di raccolta per l'attrezzatura, si prega di contattare ad esempio nel reparto locale o Consiglio comunale, le aziende di smaltimento dei rifiuti locali o presso il rivenditore.

Ci si riservano modifiche tecniche. Per errori e refusi di stampa non ci si assume alcuna responsabilità.



WEEE-Reg.-Nr. DE79663011



Indicaciones de las pilas

Las pilas no deben estar al alcance de los niños. Los niños pueden llevarse las pilas a la boca y tragarlas. Esto puede tener como consecuencia daños graves para la salud. ¡En este caso acuda rápidamente al médico! ¡Peligro de causticación por contacto con pilas derramadas o dañadas! En este caso utilice guantes de protección apropiados y limpie el compartimento de pilas con un paño seco. Las pilas no se deben calentar ni tirar al fuego (¡peligro de explosión!).

Garantía

Productos ABUS están diseñados y producidos con gran cuidado y comprobado atendiendo a las disposiciones vigentes. La garantía cubrirá exclusivamente los defectos que estén originados por errores en los materiales o en la fabricación. En caso de que se pueda demostrar un error en los materiales o la fabricación, ABUS decidirá si reparar o reemplazar la HomeTec Pro Teclado por radio. La garantía finalizará en dicho caso con la finalización del tiempo de vigencia original de la garantía. Quedan excluidas expresamente las reclamaciones que vayan más allá de lo indicado.

ABUS no se hace responsable por defectos y daños ocasionados por influencias externas (p. ej., el transporte, uso de la fuerza), manejo incorrecto, desgaste normal y la inobservancia del presente manual. Al efectuar una reclamación de garantía se deberá adjuntar al producto en cuestión la factura de compra con la fecha de compra y una descripción breve por escrito del fallo.

Declaración de conformidad

Por la presente, ABUS August Bremicker Söhne KG, Altenhofer Weg 25, 58300 Wetter, declara que este HomeTec Pro cumple con los requisitos esenciales y otras disposiciones relevantes de la Directiva 2014/53/EU cuando se utiliza según lo previsto. La declaración de conformidad se puede obtener en la siguiente dirección: ABUS August Bremicker Söhne KG, Altenhofer Weg 25, 58300 Wetter, Alemania.

Eliminación

Elimine el dispositivo de acuerdo con la Directiva 2002/96/CE sobre residuos de aparatos eléctricos y electrónicos (RAEE) (Residuos de Aparatos Eléctricos y Electrónicos). Para cualquier consulta, póngase en contacto con la autoridad local responsable de la eliminación de residuos. Para recibir información sobre los puntos de recogida para su equipo, póngase en contacto, por ejemplo, con la administración municipal, las empresas locales de eliminación de

residuos o con su proveedor.

Se reserva el derecho de realizar cambios técnicos y no se admite responsabilidad por faltas o errores de impresión.



WEEE-Reg.-Nr. DE79663011

